

# ASSOCIATION OF AMERICAN RAILROADS

**K.B. Dorsey**  
*Executive Director - Tank Car Safety*

January 18, 2013

## CASUALTY PREVENTION CIRCULAR

(CPC-1245)

**SUBJECT: Pamphlet 34 Recommended Methods for the Safe Loading and Unloading of  
Non-Pressure (General Service) and Pressure Tank Cars** T9.2

TO: THE MEMBERS AND PRIVATE CAR OWNERS:

At the request of the Haz Mat (BOE) Committee, Pamphlet 34 has been reviewed and changes made to bring it inline with current best industry practices. The objective of the pamphlet is to promote the safe loading, unloading, and preparation for transportation of tank cars. The specific revised sections are:

- Removed existing wording under item 4 Section A
- New paragraph 13 under Section A
- New item 16 under Section B
- Replace existing wording of item 22 under section B
- Includes sections 6.0 through 6.6 and tables D7 through D13 of Appendix D of AAR MSRP Section C Part III (M-1002)

Note: The information provided within section 4 of Pamphlet 34 is a reprint of sections 6.0 through 6.6 and tables D7 through D-13 of Appendix D of AAR Manual of Standards and Recommended Practices Section C Part III "Specification for Tank Cars" (M-1002). NOTE: This material will continue to be maintained under Appendix D of AAR MSRP Section C Part III (M-1002).

The revised pamphlet is included in this circular and is in effect as of the publication date of this circular. This CPC-1245 supersedes CPC-1190. Under the provisions of Standard S-050, which may be found on the TTCI web site (AAR.com), this circular reflects the final action on this matter.

Respectfully Submitted,

K.B. Dorsey

---

# **Pamphlet 34 -**

## **Recommended Methods for the Safe Loading and Unloading of Non-Pressure (General Service) and Pressure Tank Cars**

January 18, 2013

---

# TABLE OF CONTENTS

|  |    |
|--|----|
| Preface.....   | 4  |
| Section 1: General Instructions for Loading and Unloading..... | 5  |
| Section 2: Loading a Tank Car.....                             | 7  |
| 2.1 Before Loading a Tank Car .....                            | 7  |
| 2.2 During Loading a Tank Car .....                            | 9  |
| 2.3 After Loading a Tank Car .....                             | 9  |
| Section 3: Unloading a Tank Car .....                          | 11 |
| 3.1 Before Unloading a Tank Car: .....                         | 11 |
| 3.2 If Heater Coils Are Needed For Unloading .....             | 11 |
| 3.3 Unloading .....  | 12 |
| 3.4 After Unloading a Tank Car .....                           | 13 |
| Section 4: Reprint of Parts of M-1002 Appendix D .....         | 15 |
| Section 5: Additional Information .....                        | 29 |
| 5.1 Websites References .....                                  | 29 |
| 5.2 Regulation and Standard References.....                    | 29 |

---

## **Preface**

This document presents general guidelines for the selection of tank cars and recommended procedures for loading and unloading of the cars. It is not a complete and comprehensive set of methods, instructions or procedures applicable for all situations and car types. Each user company is encouraged to develop specific procedures using this document as a general guide where it applies. A particular location may require the use of additional or different precautions for the loading or unloading operations to be performed safely. Appropriate individual company procedures and applicable government requirements, including U.S. Department of Transportation (DOT) Hazardous Materials or Transport Canada (TC) Transportation of Dangerous Goods regulations, must be followed.

All repairs must be performed by properly Certified or Registered Tank Car Facilities. Experienced, trained personnel who are knowledgeable of the safety requirements and loading/unloading operations must be used. For loading and unloading of Hazardous Materials/Dangerous Goods, these knowledgeable persons must be designated as and trained as "HazMat"/or qualified employees per government regulations. Loading/unloading personnel must be responsible for compliance with all company procedures and regulatory requirements during the complete operation. See regulatory references at the end of this document.

***CAUTION:** Since the loading and unloading of tank cars involves the opening of valves, fittings, flanges, caps, plugs and other closures there is always a possibility of product spillage or leakage. While this should be minimized the loader/unloader must be prepared to capture, collect and dispose of any spilled or leaked product in an environmentally-acceptable manner.*

Appropriate Personal Protective Equipment (PPE) should be worn throughout the loading or unloading procedure.

---

## Section 1: General Instructions for Loading and Unloading

- 1.1 The car must have the hand brakes set and the wheel(s) blocked against movement before any loading/unloading activities are started.
- 1.2 When the car is positioned for loading or unloading, securely block access to the track by use of derails, aligned and locked switches, bumper blocks or other such apparatus.
- 1.3 While a car is connected for loading/unloading, blue caution signs (sometimes known as “blue flags”) must be placed on the track as required by regulations and company procedures.
- 1.4 Before loading/unloading, inspect the car for damage. If found, contact the car owner for further instructions before loading.
- 1.5 Safety equipment such as safety showers and eye wash stations should be verified to be present and operational before conducting loading/unloading activities.
- 1.6 Proper tools should be used for loading/unloading operations. They must be clean and in proper condition at all times.
- 1.7 Tank car tanks containing flammable or combustible gases or liquids should be electrically grounded and bonded during loading and unloading operations. Grounding and bonding of cars carrying other commodities is also encouraged.
- 1.8 All loading/unloading inspections should be properly documented through a check list or similar method.
- 1.9 The loading/unloading area should have adequate lighting and be free of obstacles or unnecessary equipment.
- 1.10 During the loading/unloading process, cars must be attended by trained personnel or monitored by an approved monitoring system. Do not allow the loading/unloading operation to stand unattended or unmonitored while connections are attached to the car. If necessary to discontinue operations for a period of time, all valves must be closed, all connections removed and the car must be prepared as if ready for transportation. However, operations can be discontinued on an attended or monitored car by closing valves on the car and closing valves at the facility without disconnecting hoses.
- 1.11 When operating gauging devices, top operated bottom outlet valves, or any other top fittings or closures, loaders/unloaders should not:

- 
- 1.11.1** Stand directly above or place any part of their body directly above the gauging device, valve, fitting, or closure.

***NOTE:** An excess flow valve is a device which closes automatically against the flow of the contents of the tank in case the external closure valve is broken off or removed in transit. Excess flow valves are neither designed, nor intended, to stop the flow of a tank car's contents in the event of a failure of a loading/unloading system's piping or hoses.*

- 1.12** Prior to attempting to move the gage rod loosen the packing gland nut slightly. Do not use a wrench for additional leverage to raise and/or lower sticking gage rods. Remember to retighten the packing gland nut prior to offering for transportation.

- 1.13** During loading and unloading, the pressure in the tank must not exceed the lesser of:

75% of the pressure relief valve start-to-discharge pressure; or

75% of the tank test pressure; or

60% of the rupture disc burst pressure in a combination device.

***NOTE:** Limiting the pressure below the above values helps ensure that the pressure relief device will not function during product transfer operations. For example, for a DOT111A60W1 tank car with a 75 psig pressure relief device, the pressure within the tank must not exceed 45 psig. (75% of 60 psi). Maintaining the pressure below 75% of the pressure relief valve start-to-discharge pressure helps ensure that the pressure in the tank is below the vapor tight pressure of the device, and limiting the pressure below 60% of the rupture disc pressure in a combination device ensures the pressure is below the point which disc deformation may occur.*

---

## Section 2: Loading a Tank Car

### 2.1 Before Loading a Tank Car

2.1.1 Ensure that general procedures in Section A are followed.

2.1.2 Shippers must ensure that the tank car selected is authorized for the commodity being loaded. The tank car must comply with DOT or TC regulations and/or AAR's current Manual of Standards and Recommended Practices, Section C-Part III, (Specifications for Tank Cars, Specification M-1002).

2.1.3 The tank car must be of sufficient capacity, both by weight and volume to contain the quantity of the product being loaded. Applicable requirements such as outage, filling density or weight restrictions must be met. Consult the appropriate regulations/company policies for specific filling requirements.

2.1.4 Inspect the car for overall integrity and any visible damage. All safety appliances must be in proper condition. The car must show no sign of leakage and have no visible defects.

*NOTE: During the inspection of the car, look for any items that are not typical of standard tank car designs as they may indicate a security breach – follow company-specific procedures or guidelines if such items are found.*

2.1.5 Qualification stencils should be reviewed to confirm that the car is not overdue for any tests, qualifications or inspections. Do not load a car with overdue tests, qualifications or inspections.

2.1.6 All fittings, valves, gaskets and fasteners must be in proper condition, i.e. not corroded, torn, worn, stripped or otherwise damaged. Materials contacting the lading must be compatible with the product being loaded into the car.

2.1.7 Unless the car is cleaned/purged, ensure that the residue in the car is compatible with the product being loaded into the car. Do not load a car that has an unidentified residue.

2.1.8 If equipped with a safety vent, the rupture disc must thoroughly inspected. If equipped with a pressure relief valve, the valve must be inspected to ensure no debris is in its discharge area. If a combination pressure relief device is present each detection device (including, for example, telltale indicator or needle valve) should be checked to determine the integrity of the rupture disk. These devices must be closed prior to transportation.

2.1.9 If equipped with bottom outlet valve(s), the outlet cap(s) and/or plug(s) must be removed to check the bottom outlet valve for leakage. If equipped with

---

an auxiliary valve, open the auxiliary valve with its cap/plug removed to check the bottom outlet valve for leakage. Upon removal of the plug and/or cap or opening of the auxiliary valve, be prepared for the possible release of material from the outlet leg and from a leaking valve.

- 2.1.10** If equipped with a Top Operated Bottom Outlet Valve (BOV), if practicable, loosen the top packing nut and operate the valve to verify proper operation. Depending on findings, close the valve and tighten the top packing nut or stop the operation and repair the valve before loading the car.

***CAUTION:** This process may allow material to drain into the outlet leg of the car between its BOV and auxiliary valve.*

- 2.1.11** If equipped with a Bottom Operated Bottom Outlet Valve, if practicable, operate the bottom outlet valve to verify its proper operation. Depending on findings, close the valve and lock the handle in the closed position or stop the operation and repair the valve before loading the car.

***CAUTION:** This process may allow material to drain into the outlet leg of the car between its BOV and auxiliary valve.*

- 2.1.12** The bottom outlet plug and/or cap must remain off its fitting during entire loading process to ensure that the bottom outlet valve is not leaking. If equipped with an auxiliary bottom outlet valve, the auxiliary bottom outlet valve must be left open with the plug removed during the entire loading process to ensure that the primary bottom outlet valve is not leaking.

- 2.1.13** If equipped with a heating system, thoroughly inspect the exposed parts of the system. If the car is equipped with interior heater coils, remove the caps, be prepared for release of material and check for leaks prior to loading the car.

- 2.1.14** If so equipped, remove thermometer well cap and the magnetic gage rod cover cap slowly to determine if there is a leak. Inspect the o-ring on the thermometer well fitting and the magnetic gage rod body and replace as required. Verify that adequate ethylene glycol/anti-freeze mixture is present in the thermometer well to allow for taking an accurate product temperature reading.

- 2.1.15** Where applicable, connect the vapor valve to a recovery system. Open the vapor valve for displacement of the vapor before opening any product valve or manway.

- 2.1.16** If equipped with a hinged and bolted manway thoroughly inspect the manway nozzle and cover assembly assuring that:

- 2.1.16.1** The manway cover is functional, properly aligned and centered on the manway nozzle, hinge pin operates freely, is in place and not bent, cut or



---

damaged and the eyebolt slots and ears are not bent, worn, damaged or deformed. The cover must be free of commodity or other build up that would prevent proper operation of the eyebolts. The area adjacent to the gasket sealing surface must be free of commodity or other build up that would interfere with adjacent surfaces and adjacent areas must be free of corrosion or damage that would allow passage of commodity with the cover in the closed and bolted position.

- 2.1.16.2** The manway nozzle sealing surface is free of gouges, nicks, corrosion, displaced metal, residual commodity and remnants of old gaskets.
- 2.1.16.3** The manway gasket is in place, intact, has not taken a permanent compression set that interferes with sealing, is the style and design compatible with the manway nozzle assembly and is of a material compatible with the commodity.
- 2.1.16.4** The eyebolts, nuts and washers are not bent, damaged, corroded, and the assemblies are free of excess paint or commodity. Nuts and washers must be of size to fully bridge the eyebolt slots and washers must not be deformed. The manway nozzle is equipped with safety eyebolts at the proper locations opposite the hinge side of the nozzle.
- 2.1.16.5** The eyebolt pins and hinges are not bent, damaged, deformed or worn to the extent to prevent free movement of the eyebolts and proper engagement in the manway cover eyebolt slots.

## **2.2 During Loading a Tank Car**

- 2.2.1** During loading continually monitor the car for any signs of leakage.
- 2.2.2** Ensure adequate outage space remains in the car when loading is completed to prevent overloading by volume or by weight and to allow expansion in transit. Refer to applicable regulations for correct outage, filling density and other weight restrictions for the commodity loaded.

## **2.3 After Loading a Tank Car**

- 2.3.1** When loading is complete re-check the car for any signs of leakage. If there are any signs of leakage and if the leak cannot be stopped, the car must not be offered for transportation.
- 2.3.2** Document, per company procedures, the outage level, seal numbers and product identification information.
- 2.3.3** Close all valves after car is loaded. Verify there is no detectable leakage from valves, flanges, threaded connections and packing glands. Secure all plugs and outlet caps with a suitable tool. Use non-sparking tools if required

---

by company procedures. (PTFE, Teflon®, paste or not more than three wraps of PTFE tape have been found to be acceptable materials for use in sealing plugs and caps.) {Note: In most cases exterior coils should not have caps}. Do not offer the car for transportation if any leaks are found!

*NOTE: Association of American Railroads Interchange Rules require that any leaky tank, regardless of the commodity carried, shall be stenciled, "LEAKY TANK, DO NOT LOAD UNTIL REPAIRED", in 3-inch letters, on each side adjacent to the car number, and the location of the leak must be identified by an "X". In addition, the car must be stenciled or decaled "HOME SHOP FOR REPAIRS DO NOT LOAD."*

**2.3.4** When securing a manway cover tighten the bolts using the appropriate star pattern and internal procedures. Lubricate manway eyebolts as required to maintain serviceability of the bolts and to ensure that proper torque values are achieved. Verify that the manway cover ears have not deformed or bent out of plane due to the torque applied to the eyebolts.

**2.3.5** After loading, apply and hand-tighten magnetic gauge cover and thermometer well cap.

**2.3.6** After the tank car has passed the appropriate leak test, top unloading valve handles that are not enclosed in a protective housing, must be removed before the car is offered for transportation.

*NOTE: All valves, fittings, closures, plugs, caps, and fasteners are to be checked for tool tightness even if the item was not utilized during the unloading process (thermometer and magnetic gauging device covers with o-rings are to be hand tight, not tool tight.)*

**2.3.7** Product spillage on the tank exterior must be removed.

**2.3.8** The car must be properly placarded and marked before it is offered for transportation.

---

## **Section 3: Unloading a Tank Car**

### **3.1 Before Unloading a Tank Car:**

- 3.1.1 General procedures in Section A should be followed.
- 3.1.2 All fittings seals should be examined before removing them for evidence of tampering.
- 3.1.3 Verify that valves and fittings are closed before removing plugs, caps and flanges.
- 3.1.4 Any dirt or debris should be removed from the fittings before opening them.
- 3.1.5 Before unloading, verify the contents of the tank car and of the receiving vessel for compatibility.
- 3.1.6 If the tank car is a general service car, relieve tank pressure by one or more of the following methods:
  - 3.1.6.1 Slowly opening the vent valve.
  - 3.1.6.2 Carefully open the fill hole cover or hinged manway cover. If using the manway cover for pressure relief, use caution when loosening bolts. The bolt(s) by the handle are the safety bolt(s). Loosen the safety bolt(s) by one or two turns at a time, and then loosen the remaining bolts.
  - 3.1.6.3 If necessary, vent to a scrubber or vapor collection system.

***NOTE: CAUTION should be exercised because any tank car may be under pressure.***

***NOTE: The vacuum relief valve should not be used to vent pressure.***

***NOTE: Atmospheric venting may create a safety and/or environmental hazard.***

- 3.1.7 Venting is not necessary if the tank car is to be pressure-unloaded. However, a means to prevent over-pressure must be provided.

### **3.2 If Heater Coils Are Needed For Unloading**

- 3.2.1 If equipped with interior heater coils, remove heater coil caps and check for leakage before connecting steam hoses.
- 3.2.2 Connect steam hoses to inlet connections of the heating system. Use a shut-off valve to control the steam flow. The tank should be vented before and during steaming to prevent excess pressure build-up.

- 
- 3.2.3** Caution must be taken when applying steam to the system. Apply steam slowly until steam is observed at the heater coil outlet. Rapid expansion of the coils could cause breakage of the steam system. If steam is bubbling in the product, the interior steam coil is broken. Shut off the steam. If there is a dual system on the car, use the other bank. Report defects per company procedures to the shipper of the product and/or to the car owner.
- 3.2.4** Steaming operations should be carefully monitored to ensure the product or container does not become over-heated.
- 3.2.5** If the bottom outlet valve is steam jacketed, steam should be applied to the outlet steam jacket. DO NOT apply steam directly into the outlet chamber!
- 3.2.6** When unloading general service tank cars with protective linings it is important to remember that steaming of a partially filled tank car may damage the coating due to localized overheating. Once unloading is in process, steam pressure should be reduced or shut off to the car to avoid damaging the protective lining.
- 3.3 Unloading**
- 3.3.1** When unloading through the bottom outlet, with the manway open, take care to prevent contamination of the product or, in the case of flammable materials, sparks or other sources of ignition.
- 3.3.2** Verify that the bottom valve is closed before loosening bottom outlet plug or cap.
- 3.3.3** Be prepared to collect any materials trapped in the bottom outlet leg upon loosening of the cap/plug assembly. Slowly loosen the outlet cap. If more than 2 - 3 quarts are collected in the containment system, there is a probability of bottom outlet valve leakage. Do not remove the cap completely. If the valve continues to leak tighten the cap/plug assembly. Inform the tank car owner of the leaking condition and request what action to take.
- 3.3.4** Before opening the unloading valves, securely attach the transfer system and perform a leakage test, if possible.
- 3.3.5** If a non-pressure tank car is being unloaded by pumping through the bottom outlet valve or top-mounted liquid valve, a means of preventing vacuum (which may cause a collapse of the tank) must be provided. Relieve all pressure used to unload the car, except for those products that may have a nitrogen padding applied. A warning should be applied in the manway area to indicate when nitrogen or other non-life supporting gas is present as a pad.

---

### 3.4 After Unloading a Tank Car

3.4.1 If the steam supply is still active, shut it off and remove connections. Check the heating coils for water removal and check for leaks per company procedures. If leaks are found, notify the car owner and/or the shipper.

3.4.2 Verify that all valves are closed.

3.4.3 Verify that all unloading connections are removed.

3.4.4 Secure all fittings, valves and openings in the appropriate manner. (All plugs and outlet caps must be secured with a suitable tool. Use non-sparking tools per company procedures when required.) Exceptions: Thermometer and magnetic gauging device covers with o-rings are to be hand tight, not tool tight.

***NOTE:** All valves, fittings, closures, plugs, caps, and fasteners are to be checked for tool tightness) even if they were not utilized during the unloading process again with the exceptions of thermometer and magnetic gaging device covers with o-rings that are to be hand tight, not tool tight.)*

3.4.5 If the manway was opened during the operation, be sure to inspect the manway gasket for damage, deterioration and proper alignment. Tighten the manway bolts using the appropriate star pattern and torque values per company procedures.

3.4.6 If equipped with a safety vent, the rupture disc must be examined for integrity, proper burst-pressure rating and condition. If the tank car is to be reloaded at the same facility one inspection of the rupture disc may be adequate. The key requirement is that the rupture disc be thoroughly inspected per federal requirements prior to offering for transport with the following exceptions:

3.4.6.1 Residue of some class 8 and 9 materials by Special Permit in the USA and

3.4.6.2 24.2 Most/all residue cars in Canada except class 2.

3.4.7 Relieve all pressure used to unload the car, except for those products that may have a nitrogen padding applied. A warning should be applied in the manway area to indicate when nitrogen or other non-life supporting gas is present as a pad.

3.4.8 All cars (except class 9 material under certain circumstances) must be properly placarded and marked before being offered for transportation.

3.4.9 Ensure proper documentation for transportation is available.

---

**3.4.10** Visually inspect the car to verify that no obvious defects are present.

*NOTE: A car containing the residue of a dangerous good or hazardous material must be offered for transportation in the same condition as a car loaded with that material. It must be leak free, load placarded, marked, closed with seal present if required and properly documented.*

---

## **Section 4: Reprint of Parts of M-1002 Appendix D**

The information provided within this section includes a reprint of sections 6.0 through 6.6 and tables D7 through D-13 of Appendix D of AAR Manual of Standards and Recommended Practices Section C Part III “Specification for Tank Cars” (M-1002). NOTE: This material will continue to be maintained under Appendix D of AAR MSRP Section C Part III (M-1002).

### **AAR Manual of Standards and Recommended Practices Specifications for Tank Cars**

APPENDIX D

M-1002

#### **6.0 HINGED AND BOLTED MANWAY COVER MAINTENANCE**

At each tank qualification, the following inspections, maintenance operations, and tests shall be performed on each hinged and bolted nonpressure car manway assembly.

##### **6.1 Manway Cover**

**6.1.1** Clean and visually inspect the gasket seating surface for defects. The surface is to be smooth and may have machining marks and/or 1/32-in.-deep concentric or spiral grooves machined into surface. Gouges, nicks, and other defects are acceptable up to 1/8 in. in diameter and 1/32 in. deep, provided all surrounding high spots are removed. Larger defects, or those suspected to impair sealing, shall be repaired by welding (except on covers made of ductile or malleable iron) and/or remachining, or by replacement. Machined gasket seating surfaces shall be smooth within 125-500 microinches RMS maximum roughness. Corroded or rusted gasket surfaces shall be cleaned to expose noncorroded or nonrusted metal. Surfaces that cannot be cleaned up shall be re-machined or replaced.

**6.1.2** Inspect cover operation. With the gasket removed, close the cover lightly and check that the hinge pin is free. Free up, if necessary. With a new gasket installed, close the cover lightly and check that at least 1/8-in. clearance exists at all possible contact interference points, such as at dimension “A” on the applicable manway style chart (Tables D7 through D12). Check cover for centering.

##### **6.2 Gasket**

Install a new gasket compatible with the commodity to be transported. Gasket size shall be as specified by the car manufacturer on the applicable manway style chart (Tables D7 through D12). As an alternative, manway nozzle rim style gaskets shown in Table D13 may be used, provided the gasket seats and seals properly. Care shall be exercised to remove existing commodity, old gasket, and gasket cement from gasket seating surfaces before carefully installing the new gasket.

##### **6.3 Manway Nozzle**

**6.3.1** Inspect the gasket seating surface for gouges, nicks, and other defects. File, grind, or machine raised displaced metal as detected by a straight edge. After removing raised metal, defects that are deeper than 1/32 in. and are continuous across the gasket seating surface are not acceptable. Repair defects by welding and grinding/filing or by machining. The gasket seating surface shall be smooth within 125-500 microinches RMS maximum roughness with no defects deeper than 1/32 in. continuous across the gasket surface.

**6.3.2** Inspect eyebolt and hinge lugs on the nozzle. Repair any distortion, corrosion, or cracks found.

##### **6.4 Eyebolts and Nuts**

**6.4.1** Inspect eyebolts for corrosion, damaged threads, excess paint, and residual commodity. Any defect that prevents the required nut engagement by hand is cause for cleaning, repair, or replacement.

**6.4.2** Gauge the major diameter of the external eyebolt threads over the nut clamping surface using a calibrated GO-NOGO gauge per ANSI/ASME B1.2, Table 1, or an equivalent calibrated gauge. The limiting dimension shall be the Class 1A minimum major diameter thread size.

**6.4.3** Inspect eyebolt hinge pins. Pins are to be replaced if wear or corrosion exceeds 25% of original thickness.

**6.4.4** Inspect to ensure that all manway eyebolt nuts on a given car are of the same configuration and size (i.e., heavy square or heavy hex).

**6.4.5** Inspect safety eyebolts to ensure the cover cannot be opened while the tank is under pressure.

C-III [M-1002] 190

10/2007

**AAR Manual of Standards and Recommended Practices  
Specifications for Tank Cars**

M-1002

APPENDIX D

**6.5 Testing**

**6.5.1** Any repairs to gasket seating surfaces or cover replacement require the manway to be gas tested for leaks at 15 psig minimum unless a hydrostatic tank retest is performed, subjecting the tank car's manway cover and gasket to tank test pressure.

**6.5.2** If the manway securement fails the above testing, the manway nozzle should be checked for out-of-round condition, which may prevent a proper gasket seal.

**6.6 Tightening of Bolts**

**6.6.1** Tightening sequence is to be as follows:

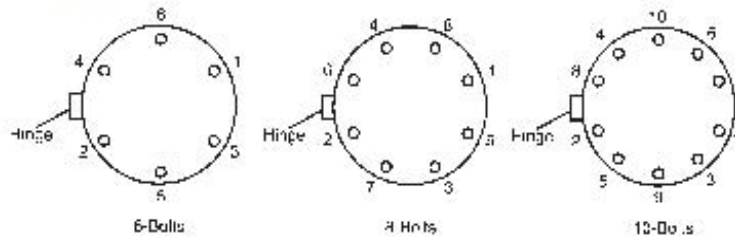

**Fig. D5 Bolt tightening sequence**

**6.6.2** Determine that thread surfaces are clean.

**6.6.3** Tighten nuts finger-tight.

**6.6.4** Tighten nuts by wrench in sequential order per the appropriate bolt pattern.

**6.6.5** After sequentially tightening, use rotational tightening and reverse rotational tightening until stable.

10/2007

C-III [M-1002] 191



**AAR Manual of Standards and Recommended Practices  
Specifications for Tank Cars**

APPENDIX D

M-1002

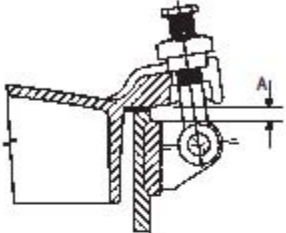
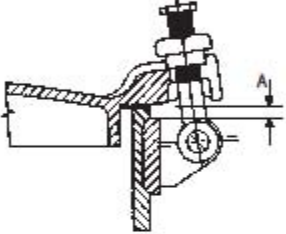
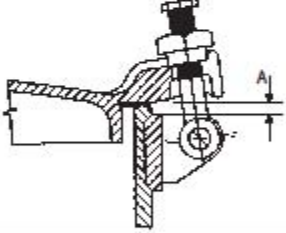
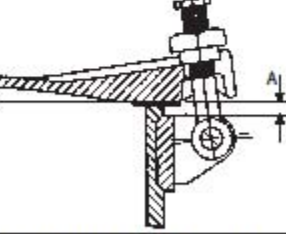
| Table D7. Manway Style Chart for ACF Industries, Inc. <sup>a/</sup><br>(page 1 of 3)   |  |                     |  |  |
|--|--|---------------------|--|--|
| Manway Style   | Nominal Dia./<br>Number of Bolts <sup>b/</sup> | Gasket Type         | Gasket Dimensions<br>(OD × ID × THbtK)           | Diagram <sup>c/</sup>  |
| ACF-1<br>(3152118)   | 18"/8  | Elastomeric<br>Hard | —<br>19 1/4" × 17" × 1/8"                        |    |
| ACF-2<br>(3156812)   | 20"/8  | Elastomeric<br>Hard | —<br>21 1/4" × 18 7/8" × 1/8"                    |    |
| ACF-3<br>(3156932)<br>(3-A-0670)   | 18"/8  | Elastomeric<br>Hard | 19" × 16 3/4" × 1/8"<br>19 1/4" × 16 7/8" × 1/8" |   |
| ACF-4<br>(417-25270)   | 18"/8  | Elastomeric<br>Hard | 20 1/2" × 17" × 1/8"<br>20 1/2" × 17" × 1/8"     |  |
| <sup>a/</sup> Alternative manway gasket styles shown in Table D13 may be substituted for those shown in this Manway Style Chart. |  |                     |  |  |
| <sup>b/</sup> Recommend manway bolts be lightly lubricated.  |  |                     |  |  |
| <sup>c/</sup> Minimum 1/8-in. clearance required at "A" for gasket compression before tightening bolts.                          |  |                     |  |  |

**AAR Manual of Standards and Recommended Practices  
Specifications for Tank Cars**

M-1002

APPENDIX D

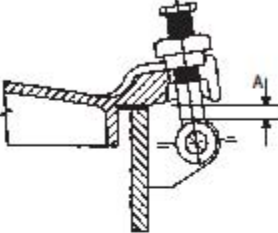
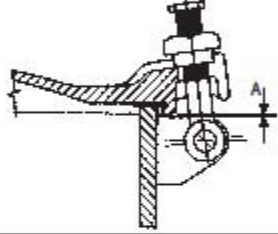
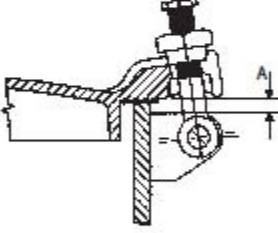
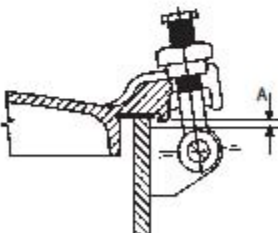
| Table D7. Manway Style Chart for ACF Industries, Inc. <sup>a/</sup><br>(page 2 of 3)   |  |                         |  |  |
|--|--|-------------------------|--|--|
| Manway Style   | Nominal Dia./<br>Number of Bolts <sup>b/</sup> | Gasket Type             | Gasket Dimensions<br>(OD × ID × THbtK)   | Diagram <sup>c/</sup>  |
| ACF-5<br>(41-74527)  | 24"/8  | Elastomeric<br><br>Hard | 25 1/4" × 22 7/8" × 1/8"<br>25 1/4" × 22 7/8" × 1/4"<br><br>25 1/4" × 22 7/8" × 1/8" |    |
| ACF-6<br>(3-C-6848)  | 20"/8  | Elastomeric<br><br>Hard | 21 7/8" × 19 1/2" × 1/8"<br><br>21 7/8" × 19 1/2" × 1/8"                             |    |
| ACF-7<br>(3-A-5299C)   | 20"/8  | Elastomeric<br><br>Hard | 21 1/2" × 18 3/4" × 1/4"<br><br>21 5/8" × 18 7/8" × 1/8"                             |   |
| ACF-8<br>(3-N-3680)  | 18"/8  | Elastomeric<br><br>Hard | —<br><br>19 1/2" × 16 7/8" × 1/8"  |  |
| <sup>a/</sup> Alternative manway gasket styles shown in Table D13 may be substituted for those shown in this Manway Style Chart.<br><sup>b/</sup> Recommend manway bolts be lightly lubricated.<br><sup>c/</sup> Minimum 1/8-in. clearance required at "A" for gasket compression before tightening bolts. |  |                         |  |  |

10/2007

C-III [M-1002] 193

**AAR Manual of Standards and Recommended Practices  
Specifications for Tank Cars**

APPENDIX D

M-1002

**Table D7. Manway Style Chart for ACF Industries, Inc.<sup>a/</sup>  
(page 3 of 3)**

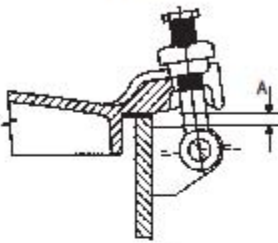
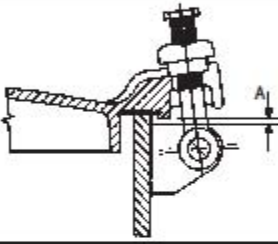
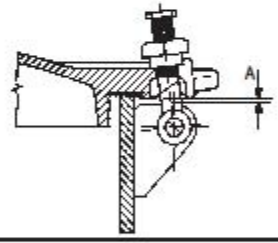
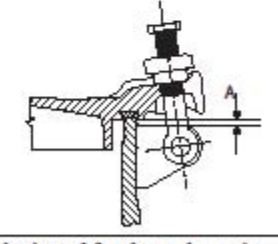
| Manway Style   | Nominal Dia./<br>Number of Bolts <sup>b/</sup> | Gasket Type         | Gasket Dimensions<br>(OD × ID × THbtK)   | Diagram <sup>c/</sup>  |
|--|--|---------------------|--|--|
| ACF-9<br>(3-F-6077)  | 20 <sup>7</sup> / <sub>8</sub>                 | Elastomeric<br>Hard | —<br>21 1/4" × 18 7/8" × 1/8"  |    |
| ACF-10<br>(3-A-5299G)  | 20 <sup>7</sup> / <sub>8</sub>                 | Elastomeric<br>Hard | 21 7/8" × 18 7/8" × 1/8"<br>21 7/8" × 18 7/8" × 1/8"<br>21 7/8" × 18 7/8" × 1/4" |    |
| ACF-11<br>(5-K-2375)<br>(5-K-4404)   | 20 <sup>7</sup> / <sub>8</sub>                 | Elastomeric<br>Hard | 21 7/8" × 18 7/8" × 1/8"<br>21 7/8" × 18 7/8" × 1/8"<br>21 7/8" × 18 7/8" × 1/4" |   |
| ACF-12<br>(3-D-5271)   | 20 <sup>7</sup> / <sub>8</sub>                 | Elastomeric<br>Hard | 21 1/8" × 19 3/4" × 1/4"<br>—  |  |
| <sup>a/</sup> Alternative manway gasket styles shown in Table D13 may be substituted for those shown in this Manway Style Chart. |  |                     |  |  |
| <sup>b/</sup> Recommend manway bolts be lightly lubricated.  |  |                     |  |  |
| <sup>c/</sup> Minimum 1/8-in. clearance required at "A" for gasket compression before tightening bolts.                          |  |                     |  |  |

**AAR Manual of Standards and Recommended Practices  
Specifications for Tank Cars**

M-1002

APPENDIX D

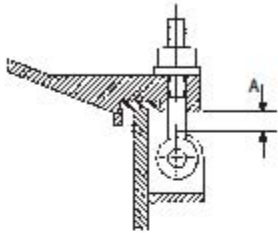
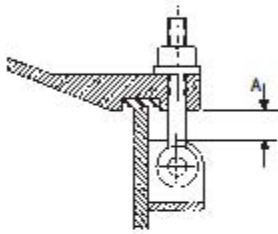
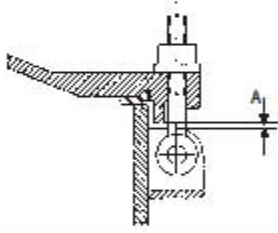
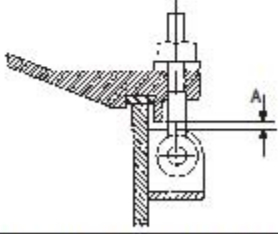
| Table D8. Manway Style Chart for General American Transportation Company <sup>a/</sup><br>(page 1 of 3)                          |  |                     |  |  |
|--|--|---------------------|--|--|
| Manway Style   | Nominal Dia./<br>Number of Bolts <sup>b/</sup> | Gasket Type         | Gasket Dimensions<br>(OD × ID × THK)                 | Diagram <sup>c/</sup>  |
| GATX #1  | 20"/6  | Elastomeric<br>Hard | 22 1/8" × 19" × 1/4"<br>22" × 19" × 1/4"             |    |
| GATX #2  | 20"/6  | Elastomeric<br>Hard | 22 1/8" × 19" × 1/4"<br>21 1/2" × 19 1/4" × 1/4"     |    |
| GATX #3  | 20"/6  | Elastomeric<br>Hard | 21 7/8" × 19" × 1/4"<br>21 5/8" × 19" × 1/4"         |   |
| GATX #4  | 20"/6  | Elastomeric<br>Hard | 21 1/2" × 18 5/8" × 1/4"<br>21 1/2" × 18 3/4" × 1/4" |  |
| <sup>a/</sup> Alternative manway gasket styles shown in Table D13 may be substituted for those shown in this Manway Style Chart. |  |                     |  |  |
| <sup>b/</sup> Recommend manway bolts be lightly lubricated.  |  |                     |  |  |
| <sup>c/</sup> Minimum 1/8-in. clearance required at "A" for gasket compression before tightening bolts.                          |  |                     |  |  |

10/2007

C-III [M-1002] 195

**AAR Manual of Standards and Recommended Practices  
Specifications for Tank Cars**

APPENDIX D

M-1002

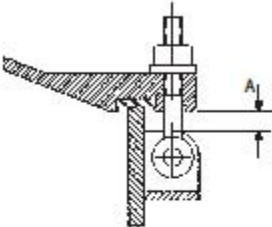
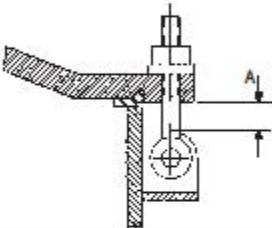
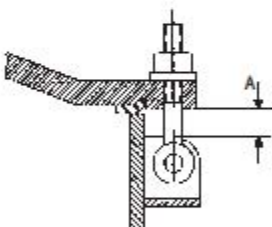
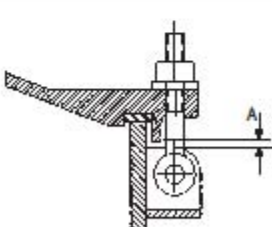
| Table D8. Manway Style Chart for General American Transportation Company <sup>a/</sup><br>(page 2 of 3)                          |  |                     |  |  |
|--|--|---------------------|--|--|
| Manway Style   | Nominal Dia./<br>Number of Bolts <sup>b/</sup> | Gasket Type         | Gasket Dimensions<br>(OD × ID × THK)                   | Diagram <sup>c/</sup>  |
| GATX #5  | 20"/6  | Elastomeric<br>Hard | 22 1/4" × 19 1/4" × 3/16"<br>22 1/8" × 19 3/8" × 1/8"  |    |
| GATX #6  | 20"/8  | Elastomeric<br>Hard | 21 7/8" × 19" × 1/4"<br>21 5/8" × 19" × 1/4"           |    |
| GATX #7  | 18"/8  | Elastomeric<br>Hard | 19 1/2" × 17" × 1/4"<br>19 3/8" × 17" × 1/4"           |   |
| GATX #8  | 20"/8  | Elastomeric<br>Hard | 21 1/2" × 19 1/4" × 1/4"<br>21 11/16" × 19 5/8" × 1/4" |  |
| <sup>a/</sup> Alternative manway gasket styles shown in Table D13 may be substituted for those shown in this Manway Style Chart. |  |                     |  |  |
| <sup>b/</sup> Recommend manway bolts be lightly lubricated.  |  |                     |  |  |
| <sup>c/</sup> Minimum 1/8-in. clearance required at "A" for gasket compression before tightening bolts.                          |  |                     |  |  |

**AAR Manual of Standards and Recommended Practices  
Specifications for Tank Cars**

M-1002

APPENDIX D

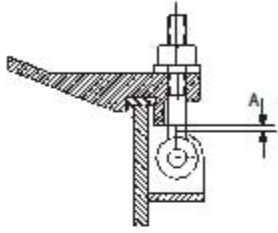
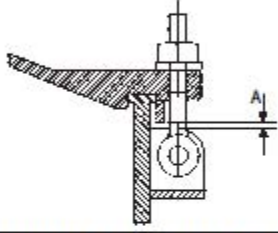
| Table D8. Manway Style Chart for General American Transportation Company <sup>w/</sup><br>(page 3 of 3)                          |  |             |                                      |  |
|--|--|-------------|--------------------------------------|--|
| Manway Style   | Nominal Dia./<br>Number of Bolts <sup>b/</sup> | Gasket Type | Gasket Dimensions<br>(OD × ID × THK) | Diagram <sup>d/</sup>  |
| GATX #9  | 18"/8  | Elastomeric | 19 5/8" × 17 1/2" × 1/4"             |  |
|  |  | Hard        | 19 5/8" × 17 1/2" × 1/4"             |  |
| GATX #10   | 20"/10   | Elastomeric | 21 1/4" × 19 5/8" × 1/4"             |  |
|  |  | Hard        | 21 1/4" × 19 7/8" × 1/4"             |  |
| <sup>w/</sup> Alternative manway gasket styles shown in Table D13 may be substituted for those shown in this Manway Style Chart. |  |             |                                      |  |
| <sup>b/</sup> Recommend manway bolts be lightly lubricated.  |  |             |                                      |  |
| <sup>d/</sup> Minimum 1/8-in. clearance required at "A" for gasket compression before tightening bolts.                          |  |             |                                      |  |

10/2007

C-III [M-1002] 197

**AAR Manual of Standards and Recommended Practices  
Specifications for Tank Cars**

APPENDIX D



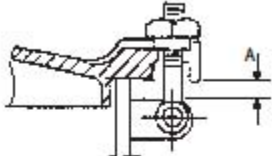
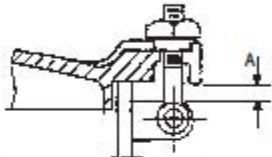

M-1002

| Table D9. Manway Style Chart for General Electric Railcar Services <sup>d</sup>   |   |             |                                      |  |
|---|---|-------------|--------------------------------------|--|
| Manway Style  | Nominal Dia./<br>Number of Bolts <sup>b</sup> | Gasket Type | Gasket Dimensions<br>(OD × ID × THK) | Diagram <sup>d</sup>   |
| GE-1  | 18"/8   | Elastomeric | 19 3/8" × 17" × 1/8"                 |  |
| GE-2  | 20"/8   | Elastomeric | 21 3/8" × 19" × 1/8"                 |  |
| <sup>a</sup> Alternative manway gasket styles shown in Table D13 may be substituted for those shown in this Manway Style Chart. |   |             |                                      |  |
| <sup>b</sup> Recommend manway bolts be lightly lubricated.  |   |             |                                      |  |
| <sup>d</sup> Minimum 1/8-in. clearance required at "A" for gasket compression before tightening bolts.                          |   |             |                                      |  |

**AAR Manual of Standards and Recommended Practices  
Specifications for Tank Cars**

M-1002

APPENDIX D

| Table D10. Manway Style Chart for Trinity Industries, Inc. <sup>a/</sup>   |  |             |                                      |  |
|--|--|-------------|--------------------------------------|--|
| Manway Style   | Nominal Dia./<br>Number of Bolts <sup>b/</sup> | Gasket Type | Gasket Dimensions<br>(OD × ID × THK) | Diagram <sup>c/</sup>  |
| TRN-1  | 20" ID/6                                       | Elastomeric | 21 1/2" × 19 1/4" × 1/4"             |  |
|  |  | Hard        | 21 11/16" × 19 5/8" × 1/8"           |  |
| TRN-2  | 20" ID/8                                       | Elastomeric | 21 1/2" × 19 1/4" × 1/4"             |  |
|  |  | Hard        | 21 11/16" × 19 5/8" × 1/8"           |  |
| TRN-3  | 20" ID/8                                       | Elastomeric | 21 1/2" × 18 7/8" × 1/8"             |  |
|  |  | Hard        | 21 1/2" × 18 7/8" × 1/8"             |  |
| TRN-4  | 20" ID/10                                      | Elastomeric | 22 1/4" × 19 1/4" × 1/8"             |  |
|  |  | Hard        | 22 1/16" × 19 7/16" × 1/8"           |  |
| <sup>a/</sup> Alternative manway gasket styles shown in Table D13 may be substituted for those shown in this Manway Style Chart. |  |             |                                      |  |
| <sup>b/</sup> Recommend manway bolts be lightly lubricated.  |  |             |                                      |  |
| <sup>c/</sup> Minimum 1/8-in. clearance required at "A" for gasket compression before tightening bolts.                          |  |             |                                      |  |

10/2007

C-III [M-1002] 199



**AAR Manual of Standards and Recommended Practices  
Specifications for Tank Cars**

APPENDIX D

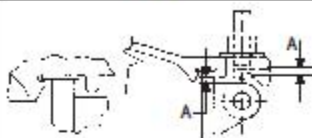
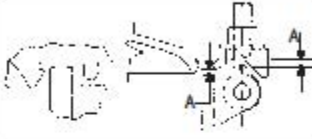
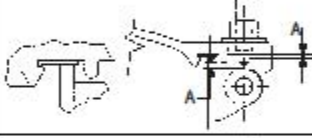
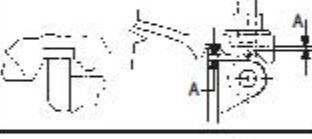
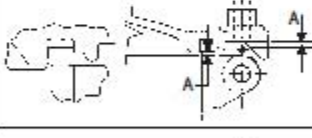
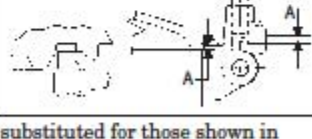

M-1002

| Table D11. Manway Style Chart for Union Tank Car Company <sup>d/</sup><br>(page 1 of 3)  |  |                     |  |  |
|--|--|---------------------|--|--|
| Manway Style   | Nominal Dia./<br>Number of Bolts <sup>b/</sup> | Gasket Type         | Gasket Dimensions<br>(OD × ID × THK)                   | Diagram <sup>d/</sup>  |
| UTC-1  | 20"/8  | Elastomeric<br>Hard | 21 1/2" × 19 7/16" × 1/8"<br>21 1/2" × 19 7/16" × 1/8" |    |
| UTC-2  | 18"/6  | Elastomeric<br>Hard | 19 1/2" × 17 7/16" × 1/8"<br>19 1/2" × 17 7/16" × 1/8" |    |
| UTC-3  | 18 1/2"/6                                      | Elastomeric<br>Hard | 19 1/2" × 17 7/16" × 1/8"<br>19 1/2" × 17 7/16" × 1/8" |    |
| UTC-4  | 20"/8  | Elastomeric<br>Hard | 21 7/16" × 19 3/4" × 1/4"<br>—                         |   |
| UTC-5  | 20"/8  | Elastomeric<br>Hard | 21 1/8" × 19 3/4" × 1/4"<br>—                          |  |
| UTC-6  | 20"/8  | Elastomeric<br>Hard | 21 5/16" × 20 3/16" × 1/4"<br>—                        |  |
| <sup>a/</sup> Alternative manway gasket styles shown in Table D13 may be substituted for those shown in this Manway Style Chart. |  |                     |  |  |
| <sup>b/</sup> Recommend manway bolts be lightly lubricated.  |  |                     |  |  |
| <sup>d/</sup> Minimum 1/8-in. clearance required at "A" for gasket compression before tightening bolts.                          |  |                     |  |  |
| <sup>d/</sup> RTC denotes cars originally built by Richmond Tank Car Company.  |  |                     |  |  |

**AAR Manual of Standards and Recommended Practices  
Specifications for Tank Cars**

M-1002

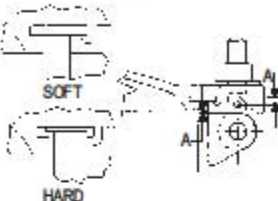
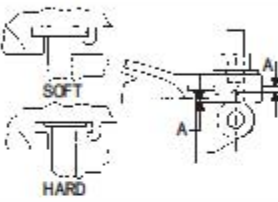
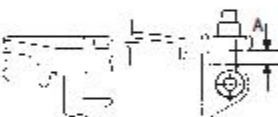
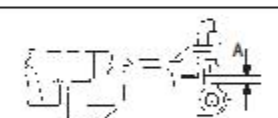
APPENDIX D

| Table D11. Manway Style Chart for Union Tank Car Company <sup>a</sup><br>(page 2 of 3)  |   |                     |  |  |
|---|---|---------------------|--|--|
| Manway Style  | Nominal Dia./<br>Number of Bolts <sup>b</sup> | Gasket Type         | Gasket Dimensions<br>(OD × ID × THK)                   | Diagram <sup>c</sup>   |
| UTC-7   | 20 <sup>7</sup> / <sub>8</sub>                | Elastomeric<br>Hard | 22 1/8" × 19" × 1/4"<br>21 13/16" × 19 9/16" × 1/8"    |    |
| UTC-8   | 18 <sup>6</sup> / <sub>8</sub>                | Elastomeric<br>Hard | 20 1/8" × 17" × 1/4"<br>19 13/16" × 17 9/16" × 1/8"    |    |
| UTC-9   | 21 <sup>8</sup> / <sub>8</sub>                | Elastomeric<br>Hard | 23" × 20 5/16" × 1/8"<br>23" × 20 1/2" × 1/8"          |    |
| UTC-10  | 20 <sup>8</sup> / <sub>8</sub>                | Elastomeric<br>Hard | 21 1/2" × 19 5/16" × 1/8"<br>21 1/2" × 19 5/16" × 1/8" |   |
| UTC-11  | 20 <sup>6</sup> / <sub>8</sub>                | Elastomeric<br>Hard | 21 1/2" × 19 1/2" × 1/4"<br>21 1/4" × 19 1/2" × 1/8"   |  |
| UTC-12  | 18 <sup>4</sup> / <sub>4</sub>                | Elastomeric<br>Hard | 19 1/2" × 17 1/2" × 1/4"<br>19 1/4" × 17 1/2" × 1/8"   |  |
| <sup>a</sup> Alternative manway gasket styles shown in Table D13 may be substituted for those shown in this Manway Style Chart. |   |                     |  |  |
| <sup>b</sup> Recommend manway bolts be lightly lubricated.  |   |                     |  |  |
| <sup>c</sup> Minimum 1/8-in. clearance required at "A" for gasket compression before tightening bolts.                          |   |                     |  |  |
| <sup>d</sup> RTC denotes cars originally built by Richmond Tank Car Company.  |   |                     |  |  |



10/2007

C-III [M-1002] 201

**AAR Manual of Standards and Recommended Practices  
Specifications for Tank Cars**

APPENDIX D

M-1002

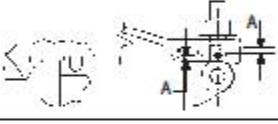
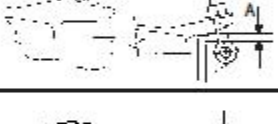
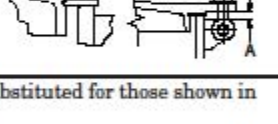
| Table D11. Manway Style Chart for Union Tank Car Company <sup>d</sup><br>(page 3 of 3)  |   |                     |  |   |
|---|---|---------------------|--|---|
| Manway Style  | Nominal Dia./<br>Number of Bolts <sup>b</sup> | Gasket Type         | Gasket Dimensions<br>(OD × ID × THK)   | Diagram <sup>d</sup>  |
| UTC-13  | 18"/8   | Elastomeric<br>Hard | 19" × 18 1/2" × 1/4" dia.<br>—   |  |
| UTC-14  | 18"/8   | Elastomeric<br>Hard | 19" × 18 1/2" × 1/4" dia.<br>—   |  |
| RTC-1 <sup>d</sup>  | 20"/8   | Elastomeric<br>Hard | 21 5/8" × 18 3/4" × 1/4"<br>21 5/8" × 18 3/4" × 1/8"<br>21 5/8" × 19" × 1/4" |   |
| RTC-2 <sup>d</sup>  | 20"/6   | Elastomeric<br>Hard | 21 5/8" × 18 3/4" × 1/4"<br>21 5/8" × 18 3/4" × 1/8"<br>21 5/8" × 19" × 1/4" |   |
| RTC-3 <sup>d</sup>  | 18"/8   | Elastomeric         | 19" × 16 3/4" × 1/8" dia.  |  |
| <sup>a</sup> Alternative manway gasket styles shown in Table D13 may be substituted for those shown in this Manway Style Chart. |   |                     |  |   |
| <sup>b</sup> Recommend manway bolts be lightly lubricated.  |   |                     |  |   |
| <sup>c</sup> Minimum 1/8-in. clearance required at "A" for gasket compression before tightening bolts.                          |   |                     |  |   |
| <sup>d</sup> RTC denotes cars originally built by Richmond Tank Car Company.  |   |                     |  |   |

**AAR Manual of Standards and Recommended Practices  
Specifications for Tank Cars**

M-1002

APPENDIX D

| Table D12. Manway Style Chart for AAR Standard Gaskets <sup>a/</sup>   |  |             |                                      |   |
|--|--|-------------|--------------------------------------|---|
| Manway Style   | Nominal Dia./<br>Number of Bolts <sup>b/</sup> | Gasket Type | Gasket Dimensions<br>(OD × ID × THK) | Diagram <sup>d/</sup>   |
| AAR-1  | 20"/6-8-10                                     | Elastomeric | 21 11/16" × 19 1/2" × 1/4"           | See Figs. E26A, B, and C for typical manway cover gasket grooves. |
|  |  | Hard        | 21 5/8" × 19 1/2" × 1/8"             |   |
| <sup>a/</sup> Alternative manway gasket styles shown in Table D13 may be substituted for those shown in this Manway Style Chart. |  |             |                                      |   |
| <sup>b/</sup> Recommend manway bolts be lightly lubricated.  |  |             |                                      |   |
| <sup>d/</sup> Minimum 1/8-in. clearance required at "A" for gasket compression before tightening bolts.                          |  |             |                                      |   |

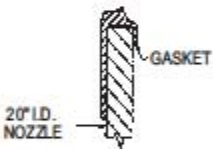
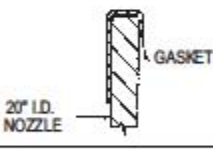
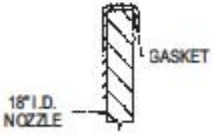
| Table D13. Manway Style Chart for Alternate Manway Gasket Styles                               |  |                        |                                      |   |
|--|--|------------------------|--------------------------------------|---|
| Manway Style   | Nominal Dia./<br>Number of Bolts <sup>a/</sup> | Gasket Type            | Gasket Dimensions<br>(OD × ID × THK) | Diagram <sup>b/</sup>   |
| GATX #3, 6, 7  | See Manway Style Chart                         | Elastomeric            | Bevel groove style                   |    |
| GATX #3, 6   | 20"/6<br>with 5/8" wall<br>nozzle              | Elastomeric            | Nozzle rim style                     |   |
| Various  | 20"/6-8-10<br>with 5/8" wall<br>nozzle         | Elastomeric<br>or hard | Nozzle rim style                     |  |
| Various  | 18"/6-8-10<br>with 5/8" wall<br>nozzle         | Elastomeric<br>or hard | Nozzle rim style                     |  |
| <sup>a/</sup> Recommend manway eyebolts be lightly lubricated.                                 |  |                        |                                      |   |
| <sup>b/</sup> Check for interference between nozzle rim gasket and shear ring on manway cover. |  |                        |                                      |   |

10/2007

C-III [M-1002] 203

---

## Section 5: Additional Information

### 5.1 Websites References

AAR/TTCI NAR Website - <http://nar.aar.com>  
BOE/TTCI Website – <http://boe.aar.com>  
Federal Railroad Administration (FRA) - <http://www.fra.dot.gov/>  
DOT Hazmat Safety Homepage - <http://hazmat.dot.gov/>  
Transport Canada (Dangerous Goods, TDG) - <http://www.tc.gc/tdg/menu.htm>  
Transport Canada (Rail) - <http://www.tc.gc.ca/rail/menu.htm>

### 5.2 Regulation and Standard References

Hazard Materials Employee Training – 49 CFR 172.704  
Dangerous Goods Employee Training – TDG Clear Language Regulations, Part 6  
Empty Packaging – 49 CFR 173.29  
Examination Before Shipping - 49 CFR 173.31(d) or CGSB 43.147, section 30.16  
Tank Car Unloading (transloading only) – 49 CFR 174.67  
Tank Car Loading and Unloading in Canada – CGSB 43.147, section 30.14  
Stencil Leaky Tank – Field Manual AAR Interchange Rule 1, 3.e. and Rule 80 B. 6.  
Hinged Manway Covers – AAR MSRP, M-1002, Appendix D.